

Article number: 20192B30B30402SW

Description: E+G

T-angle clamps GN192-B30-B30-40-2-SW

Measures

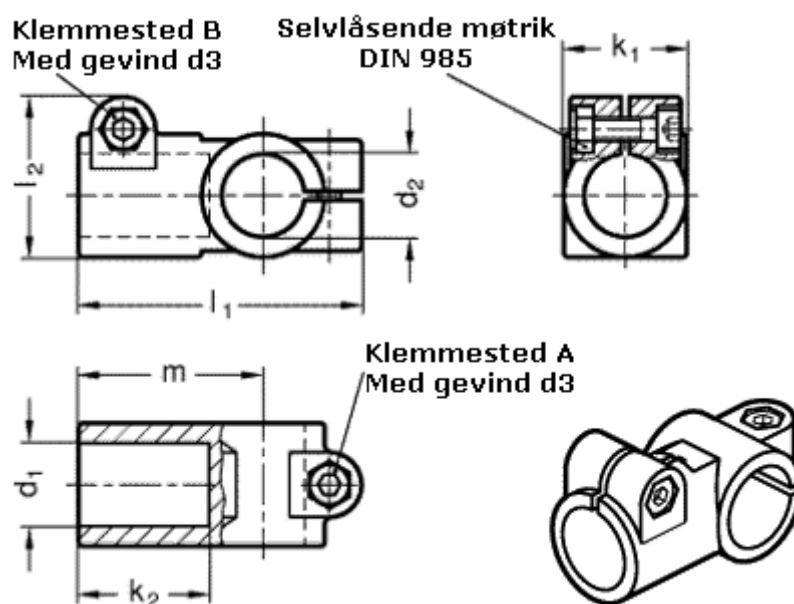

d1 = B30

d2 = B30

d3 = M 8

k1 = 40

k2 = 42.5

l1 = 92

l2 = 52.0

m = 60